

Fixed Attenuators (N,BNC,TNC)

AT-400, AT-500, and AT-600 Series



■ Features

1.Connector Coupling Portion Variations

Coupling Portion		HRS Series Name
N Type	Plug - Jack※	AT-400 Series
BNC Type	Plug - Jack	AT-500 Series
TNC Type	Plug - Jack	AT-600 Series

※Can also be mated with an S type connector.

2.Small Size and Economical

Value engineering has been liberally applied to the design and construction to make these attenuators small and very economical.

3.High Reliability

These attenuators show stable characteristics for environments of varying temperature, humidity, and gases.

■ Product Specifications

Ratings	Frequency range	AT-400 Series	DC ~ 13 GHz	Operating temperature range Operating relative humidity	-10°C to +65°C 95% Max.
		AT-500 Series	DC ~ 4 GHz		
		AT-600 Series	DC ~ 6 GHz		
	Characteristic impedance	50 ohms			
	Maximum Input Power	2W			

Item	Standard	Conditions
1.Vibration	No electrical discontinuity of 1 μs or more No damage, cracks, or parts dislocation	Frequency of 10 to 2000 Hz, overall amplitude of 1.52 mm, acceleration of 98 m/s ² for 2 hours in each of 3 directions
2.Shock		Acceleration of 490 m/s ² , sine half-wave waveform, 3 cycles in each of the 3 axis
3.Temperature cycle	No damage, cracks, or parts dislocation	Temperature: -55°C → +15°C to +35°C → +85°C → +15°C to +35°C Time: 30 → 15 max. → 30 → 15 max. (Minutes) 100 cycles

●The test method conforms to MIL-STD-202.

■ Materials

Part	Material	Finish
Connector Body	Brass	Nickel plating
Insulator	PTFE	—
Male contacts	Brass	Gold plating
Female contacts	Beryllium copper	Gold plating
Attenuation element	Metal film	—

■ Ordering Information

AT - 4 01 (40)

① ② ③ ④

① AT: Indicates a fixed attenuator	③ Attenuation (Example) 01 : 1dB 06 : 6dB
② Indicates the Series Name (Coupling Portion) 4: N plug - jack 5: BNC plug - jack 6: TNC plug - jack	④ (40): RoHS compliant

■ Specifications

Part Number	Frequency Range (MHz)	V.S.W.R.(Max)	Attenuation (dB)	Power (W) _c	Connectors	Weight (g)	RoHS
AT-401(40)	DC~2000	1.15	1±0.3	2	N-P · J	77	
	2000~4000	1.20	1 ^{+0.5} _{-0.3}				
	4000~13000	1.25	1 ^{+0.6} _{-0.3}				
AT-402(40)	DC~2000	1.15	2±0.3				
	2000~4000	1.20	2 ^{+0.5} _{-0.3}				
	4000~13000	1.25	2 ^{+0.6} _{-0.3}				
AT-403(40)	DC~2000	1.15	3±0.3				
	2000~4000	1.20	3 ^{+0.5} _{-0.3}				
	4000~13000	1.25	3 ^{+0.7} _{-0.3}				
AT-406(40)	DC~2000	1.15	6±0.3				
	2000~4000	1.20	6 ^{+0.5} _{-0.3}				
	4000~13000	1.25	6 ^{+0.7} _{-0.3}				
AT-410(40)	DC~2000	1.15	10±0.5				
	2000~4000	1.20	10 ^{+0.8} _{-0.5}				
	4000~13000	1.25	10 ^{+1.0} _{-0.5}				
AT-420(40)	DC~2000	1.15	20±0.5				
	2000~4000	1.20	20 ^{+0.8} _{-0.5}				
	4000~13000	1.25	20 ^{+1.2} _{-0.7}				
AT-501	DC~1000	1.15	1±0.3	2	BNC-P · J	25	YES
	1000~2000	1.25	1±0.3				
	2000~4000	1.25	1 ^{+0.5} _{-0.3}				
AT-503(40)	DC~1000	1.15	3±0.3				
	1000~2000	1.25	3±0.3				
	2000~4000	1.25	3 ^{+0.5} _{-0.3}				
AT-506(40)	DC~1000	1.15	6±0.3				
	1000~2000	1.25	6±0.3				
	2000~4000	1.25	6 ^{+0.5} _{-0.3}				
AT-510(40)	DC~1000	1.15	10±0.5				
	1000~2000	1.25	10±0.5				
	2000~4000	1.25	10 ^{+0.8} _{-0.5}				
AT-520(40)	DC~1000	1.15	20±0.5				
	1000~2000	1.25	20±0.5				
	2000~4000	1.25	20 ^{+0.8} _{-0.5}				
AT-601(40)	DC~1000	1.15	1±0.3	2	TNC-P · J	29	
	1000~2000	1.20	1±0.3				
	2000~6000	1.35	1 ^{+0.5} _{-0.3}				
AT-603(40)	DC~1000	1.15	3±0.3				
	1000~2000	1.20	3±0.3				
	2000~6000	1.35	3 ^{+0.5} _{-0.3}				
AT-606(40)	DC~1000	1.15	6±0.3				
	1000~2000	1.20	6±0.3				
	2000~6000	1.35	6 ^{+0.7} _{-0.3}				
AT-610(40)	DC~1000	1.15	10±0.5				
	1000~2000	1.20	10±0.5				
	2000~6000	1.35	10 ^{+1.0} _{-0.5}				
AT-620(40)	DC~1000	1.15	20±0.5				
	1000~2000	1.20	20±0.5				
	2000~6000	1.35	20 ^{+1.0} _{-0.5}				

External Dimensions

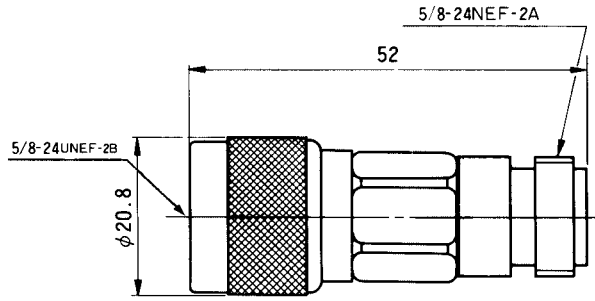

AT-400 Type

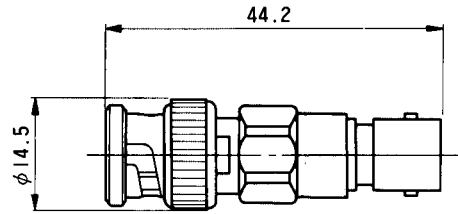

AT-500 Type

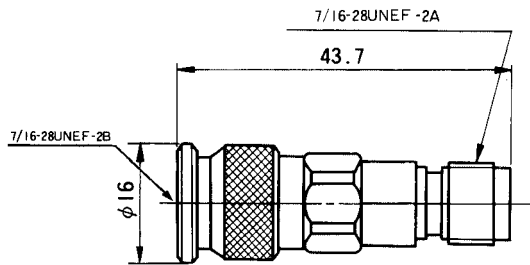

AT-600 Type

Typical Data

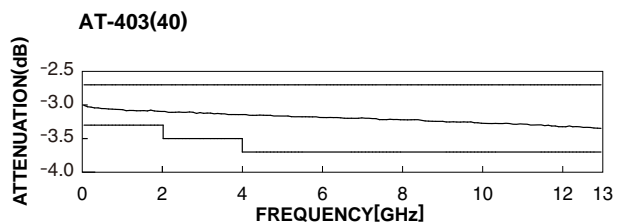
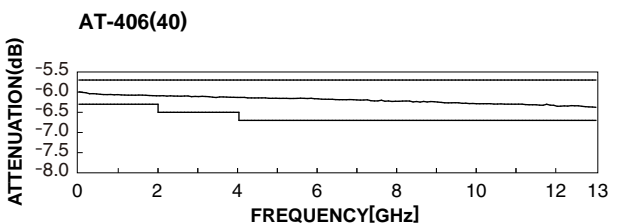
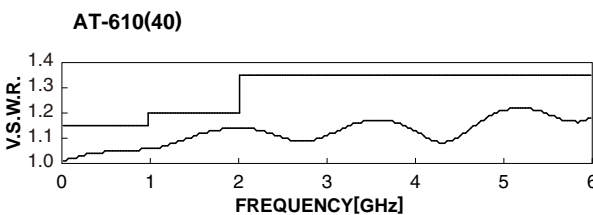
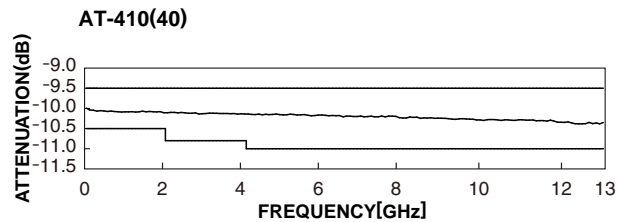
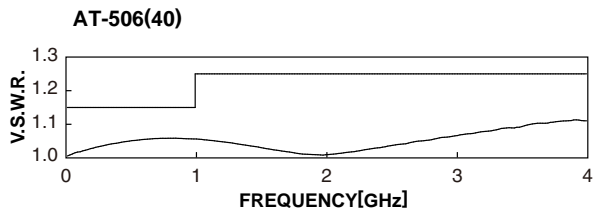
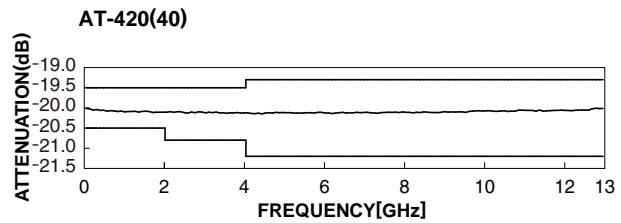
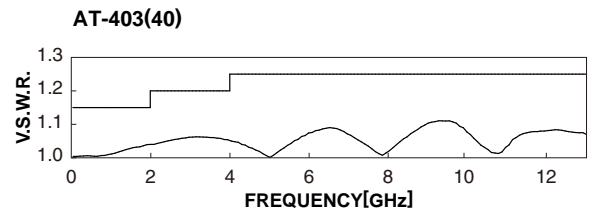

Apr.1.2019 Copyright 2019 HIROSE ELECTRIC CO., LTD. All Rights Reserved.