

# Car Audio/Infotainment System Connector Lineup

Hirose Electric, a world leader in the development of innovative electronic connectors over the last 70 years, offers a number of different connector solutions for car audio and infotainment system need. For details on these products and to view our full line of connectors, please visit our website.

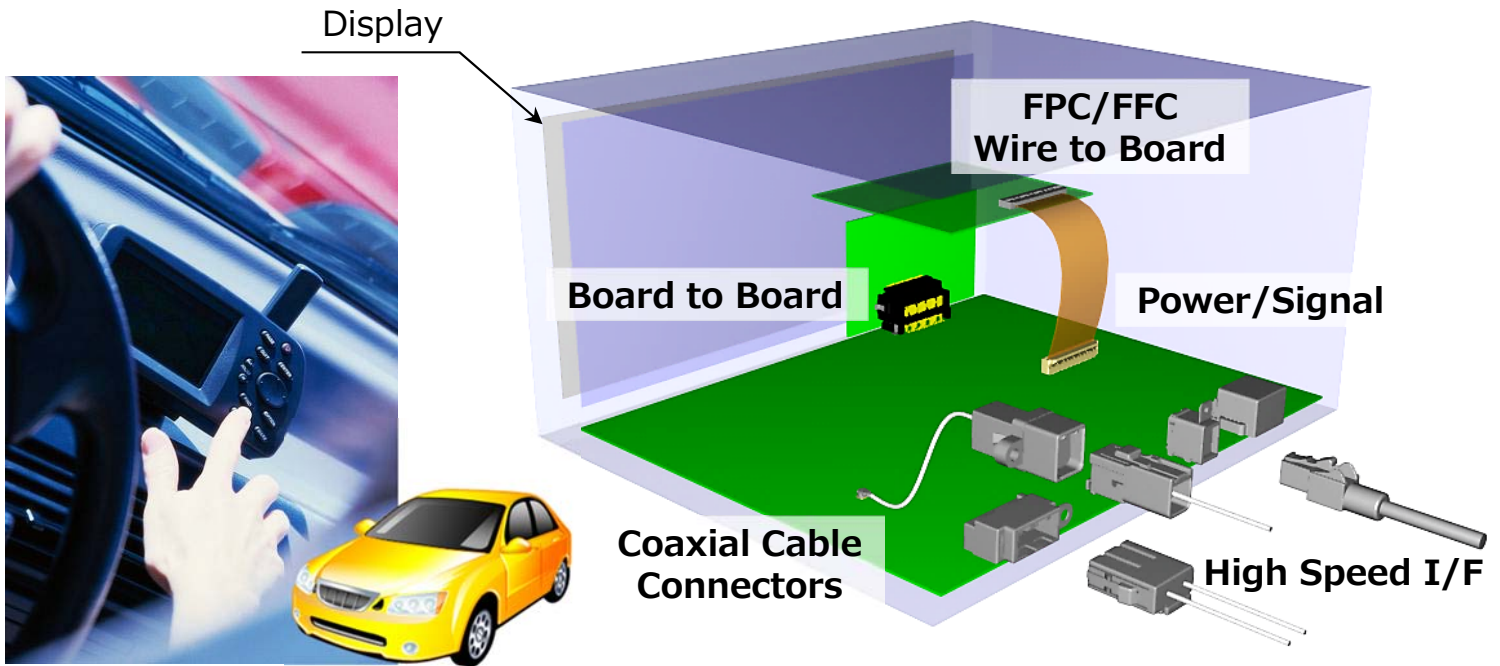

## High Speed Interface Connectors

### GT17H/GT17HN

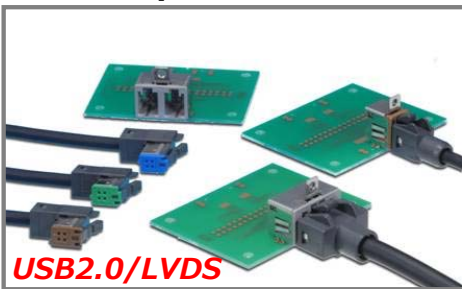

**USB2.0/LVDS**

Supports USB2.0/IEEE1394/LVDS/GVIF signal transmission, Up to 1Gbps  
DIP type  
Right angle/straight

### GT32



**HDMI/USB3.0/LVDS**

4pos.: LVDS (up to 3Gbps)  
10pos.: USB3.0 (up to 5Gbps)  
19pos.: HDMI1.4 Type E signal transmission (up to 2Gbps)  
Dip type  
Right angle/straight

## Power/Signal Connectors

### GT25

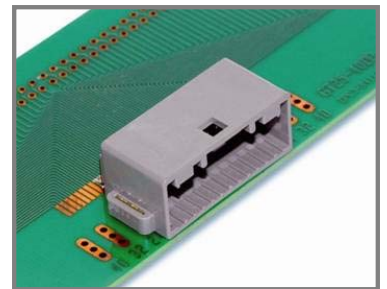

Tab size: 0.25/0.64  
Pin counts: 8-40pos.  
Rated current: 3A  
SMT type  
Right angle/straight

## Coaxial Cable Connectors for Antenna

### GT36 GPS/Radio/TV

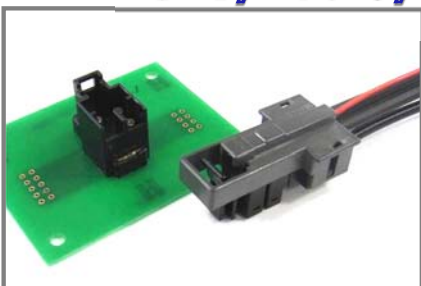

One step connection  
Small size  
Multiple coaxial cables to PCB  
Frequency: DC to 2.5GHz

### GT36A GPS/ETC/TEL

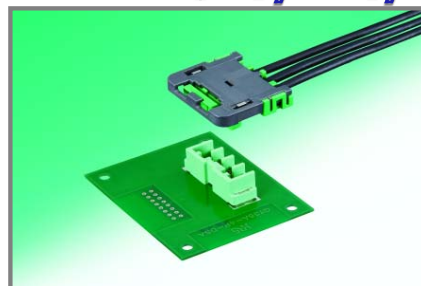

Low profile  
Small RF connector  
Frequency: DC to 5.9GHz  
DIP type

### GT36S GPS/Radio



One-step crimp termination  
Small size  
Frequency: DC to 3GHz  
DIP type



**FX23**

Pitch: 0.5mm  
 Height: 15-30mm  
 High speed transmission (8Gbps)  
 Floating: ±0.6mm  
 Vertical/right angle connection



**FX20**

Pitch: 0.5mm  
 Height: 15-30mm  
 Floating: ±0.6mm  
 Vertical/right angle connection



**DF12**

Pitch: 0.5mm  
 Height: 3.0-5.0mm  
 Depth: 4.6mm  
 Pin counts: 10 to 80pos.



**DF40GL**

Pitch: 0.5mm  
 Height: 1.5mm  
 Depth: 3.68mm  
 Pin counts: 44pos.

## FPC/FFC Connectors



**FH63**



**FH52E/  
FH52K/  
FH52T**

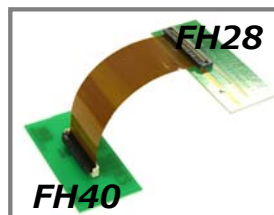

**FH40**



**FH28  
FH41  
FH48**

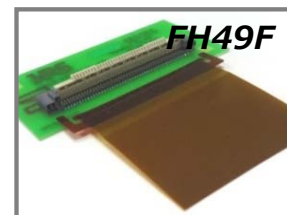

**FH49F**

	FPC/FFC	Pitch (mm)	Height (mm)	Depth (mm)	Pin counts	Remarks
<b>FH63</b>	FPC/FFC	0.5	2.8	5.15	20-60	Bottom, One action
<b>FH52E/K/T</b>	FPC/FFC	0.5	2.0	5.7	4-68	Bottom
<b>FH40</b>	FPC/FFC	0.5	5.8	3.55	10-80	Vertical
<b>FH28</b>	FPC/FFC	0.5	2.55	6.4	10-80	Bottom
<b>FH48</b>	Shielded FFC	0.5	6.18	4.7	20-68	Vertical
<b>FH41</b>	Shielded FFC	0.5	2.5	6.2	10-80	Bottom
<b>FH49F</b>	FPC	0.4	4.0	6.45	96	Bottom

## Wire to Board Connectors

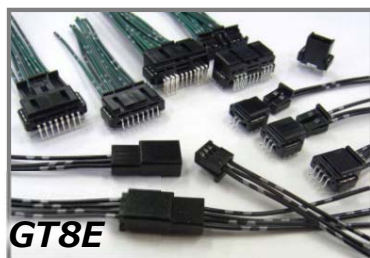

**GT8E**

Pitch: 2.0mm  
 AWG: 20 to 28  
 Pin counts: 20-24  
 DIP/SMT type  
 Straight/right angle

## Coaxial Cable Connectors for Antenna



**U.FL**

Frequency: DC to 6GHz  
 V.S.W.R.: 1.4 Max.  
 Mated height: 2.0/2.5mm

For more information about Hirose products

[Japan] TEL: +81-45-620-3491  
 [China] (Shanghai) TEL: +86-21-6391-3355  
 (Beijing) TEL: +86-10-5165-9332  
 (Shenzhen) TEL: +86-755-8207-0851  
 [Hong Kong] (Kowloon) TEL: +852-2803-5338  
 [Taiwan] (Taipei) TEL: +886-2-2555-7377  
 [Korea] (Siheung) TEL: +82-31-496-7000  
 [Singapore] (Anson Road) TEL: +65-6324-6113  
 [India] (Delhi) TEL: +91-12-660-8018  
 (Bangalore) TEL: +91-80-4120-1907  
 [Malaysia] (Penang) TEL: +604-619-2564  
 [Thailand] (Bangkok) TEL: +66-2-686-1255  
 [USA] (Chicago) (USA HQ) TEL: +1-630-282-6700  
 (San Jose) TEL: +1-408-253-9640  
 (Detroit) (Automotive) TEL: +1-734-542-9963

[The Netherlands] (Amsterdam) TEL: +31-20-6557460  
 [Germany] (Stuttgart) TEL: +49-711-456002-221  
 (Nuremberg) TEL: +49-911-326889-63  
 (Hanover) TEL: +49-511-978261-30  
 [France] (Paris) TEL: +33-1-85764886  
 [UK] (Milton Keynes) TEL: +44-1908-202050

<https://www.hirose.com/>



Specifications herein are subject to change without notice. Contact Hirose for latest specifications, drawings, or availabilities.