

# Hirose Connectors for Ultrasound Scanning System

The products depicted in this brochure are a sampling of the many connector solutions manufactured by Hirose. Please visit our Web site for details of the listed products as well as other related product lines.

## LCD I/O

### DH

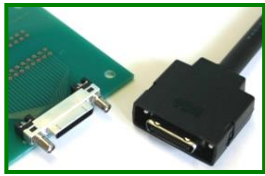

1mm pitch  
High speed transmission

## Ultrasound Scanning System

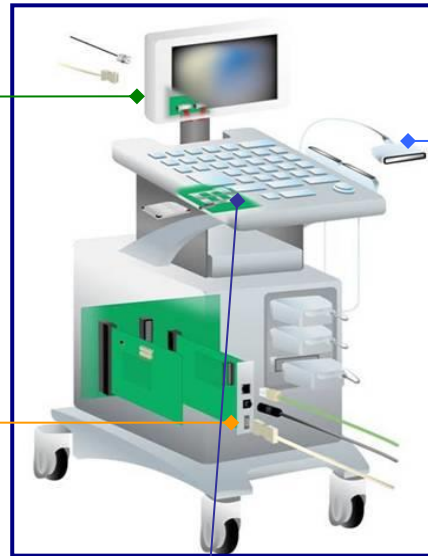

## Probe I/O

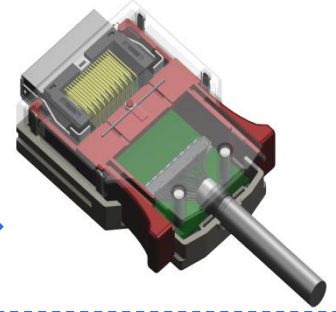

## USB

### GT17H



Positive lock USB connector

### EX

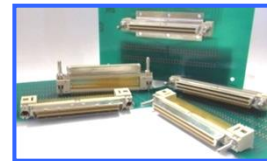

Low insertion force I/O  
280pos.

### FH28

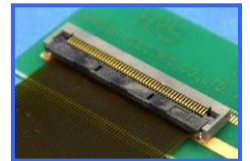

0.5mm pitch  
Robust FPC  
(10-80pos.)

## Control Board

### FX18

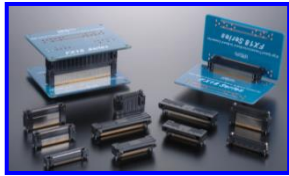

0.8mm pitch Board-Board  
(40-140pos.)

### EX80

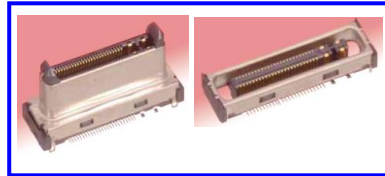

0.6mm pitch  
Shielded mezzanine  
(54 and 100pos.)

### DF80

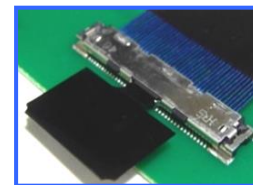

Micro coaxial  
30, 40, 45, 50pos.  
40-46 AWG wire

### DF81

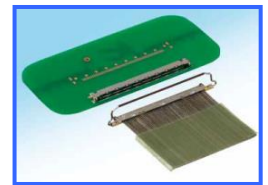

Micro coaxial  
30, 40, 50pos.  
34, 36, 40-46 AWG wire

### FH41

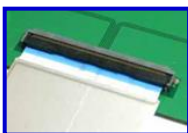

0.5mm pitch  
Shielded FFC

### FH48

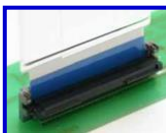

### XG1

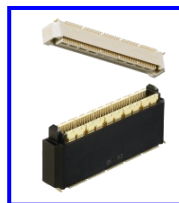

0.5mm pitch  
High speed transmission  
Mezzanine  
(130-260pos.)

### FX10



0.5mm pitch  
Mezzanine connector  
Stacking height:  
2-8mm

### FX11

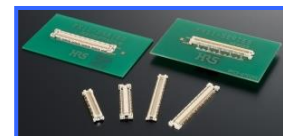

0.5mm pitch  
Mezzanine connector  
Stacking height:  
2-8mm

For more information about Hirose products: <http://www.hirose.com>

[Japan]		TEL: +81-45-620-3491	[Malaysia]	(Penang)	TEL: +604-619-2564
[China]	(Shanghai)	TEL: +86-21-6391-3355	[Thailand]	(Bangkok)	TEL: +66-2-686-1255
	(Beijing)	TEL: +86-10-5165-9332	[USA]	(Chicago)	TEL: +1-630-282-6700
				(USA HQ)	
[Hong Kong]	(Shenzhen)	TEL: +86-755-8207-0851		(San Jose)	TEL: +1-408-253-9640
	(Kowloon)	TEL: +852-2803-5338		(Detroit)	TEL: +1-734-542-9963
				(Automotive)	
[Taiwan]	(Taipei)	TEL: +886-2-2555-7377	[The Netherlands]	(Amsterdam)	TEL: +31-20-6557450
[Korea]	(Siheung)	TEL: +82-31-496-7000	[Germany]	(Stuttgart)	TEL: +49-711-4560021
		or 7124			
[Singapore]	(Anson Road)	TEL: +65-6324-6113		(Nuremberg)	TEL: +49-911-32688963
[India]	(Delhi)	TEL: +91-12-660-8018		(Hanover)	TEL: +49-511-97826130
	(Bangalore)	TEL: +91-80-4120-1907	[France]	(Paris)	TEL: +33-1-85764886
			[UK]	(Milton Keynes)	TEL: +44-1908-202050

Specifications herein are subject to change without notice. Contact Hirose for the latest specifications, drawings, and availabilities.